

Compressed Gas Silencers

A wide range of silencers for
vacuum pumps and compressors



Compressed Gas Silencers

IAC Acoustics is among the world's leading providers of solutions to industrial noise problems.

All IAC Acoustics' silencers are fully welded and constructed using carbon steel. IAC Acoustics provides a complete solution, with a range of standard products for vacuum pumps and compressors where operating pressure inside the silencer is below 0.5 bar.

- Adaptability - new or existing facilities
- A standard range, or can be customised to suit individual needs
- Short lead times available thanks to in-house lean manufacturing techniques
- A longstanding history of acoustic, thermal and hydraulic expertise
- In-house research and development laboratory for constant product development
- Guaranteed performance

Acoustic Performance

The acoustic performance of the SR range of silencers has been optimised through continuous improvement and investment in product development. Our range comprises of 2 noise reduction principles to suit individual performance requirements:

- Absorptive silencers - SR15 and SR25
- Reactive and wave displacement device, together with an absorption device - SR30, SR40 and SR40S

In order to eliminate the transmission of vibration it is highly recommended that the silencer and inlet are separated by a flexible coupling.

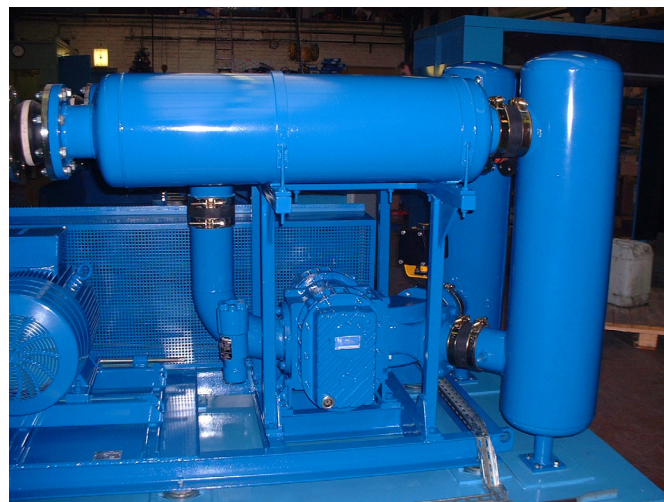

Options

- Special external protection
- Individual finishing colours available
- 304L or 316L stainless steel available
- Flanges, counter-flanges, joints and bolts available
- Dedicated supports
- Oil separators
- Exterior insulation blankets
- Water separators (SR40S)
- Soundproofing materials:
 - Glass fibre
 - High temperature polyurethane foam
 - 434 stainless steel wool
 - Feeder polyurethane foam

Compressed Gas Silencers

Individual Product Description

The nominal diameter of the inlet and outlet tubing (DN) as well as the noise reduction class, determines the name of the silencer.

- E.g. - SR15 DN50 where 15 is the noise reduction class in dB and 50 is the nominal diameter in mm.

Selection Criteria

After selecting the silencer according to the noise reduction requirement, use the following tables to determine the nominal diameter according to the flow rate (Qv) in m³/h and the pressure loss in Pascal.

Installation

Our silencers can be installed in either horizontal or vertical positions depending on the space available and layout of the existing / planned piping. IAC Acoustics is able to advise on the optimum layout.

SR15 / SR25

Nominal Diameter	50	65	80	100	125	150	175	200	225	250	300	350
Flow Rate, Qv m ³ /h	280	440	620	990	1520	2230	3000	3890	4880	6090	8680	10400
ΔP SR15 (Pa)	145	125	108	113	109	113	111	109	107	110	107	83
ΔP SR25 (Pa)	1414	1223	1058	1105	1067	1107	1082	1066	1048	1070	1049	813
ØDE (mm)	154	154	204	204	254	304	304	354	404	454	504	555
LC (mm)	338	400	507	607	760	966	1006	1173	1348	1510	1710	2015
LT (mm)	456	556	651	767	876	1086	1206	1345	1534	1720	1900	2164
SR15 Weight (kg)	4	4	8	9	16	26	27	36	49	57	80	109
SR25 Weight (kg)	4	4	9	11	18	29	30	42	56	67	92	125
ØE (mm)	60	76	89	114	140	168	194	220	246	274	324	356

Dimensions are quoted without flange. Please add 4mm for each welded flange. Tolerances for silencer lengths up to 4000mm is ±4mm. This product range has been designed for engine running below 1200rpm. For higher speed, please contact IAC Acoustics. Figures given above are based on an air temperature of 20°C

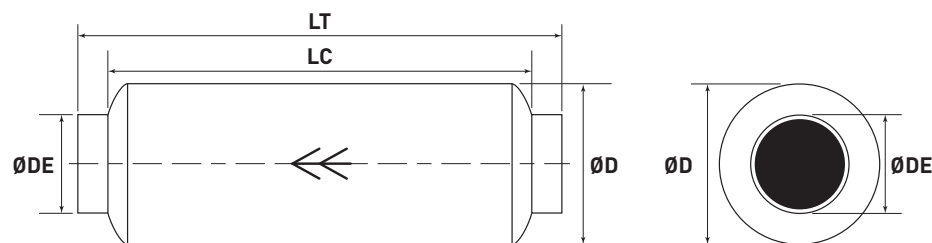
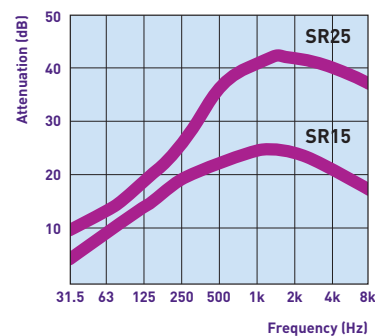

SR30

Nominal Diameter	50	65	80	100	125	150	175	200	225	250	300	350
Qv m ³ /h	190	300	410	660	1020	1480	2000	2590	3260	4060	5720	6930
ΔP (Pa)	1019	889	724	769	752	763	752	740	732	745	713	565
ØD (mm)	184	204	250	304	404	455	505	555	605	655	755	855
PE (mm)	165	175	210	230	300	330	330	375	405	450	475	550
LE (mm)	440	590	710	880	1025	1250	1440	1670	1880	2260	2500	2850
E (mm)	70	70	70	70	100	100	110	110	110	110	110	120
LT (mm)	560	740	900	1100	1250	1540	1750	2050	2300	2650	2980	3350
Weight (kg)	7	11	17	27	43	72	90	118	160	198	286	376
ØDE (mm)	60	76	89	114	140	168	194	220	246	274	324	356

Dimensions are quoted without flange. Please add 4mm for each welded flange. Tolerances for silencer lengths up to 4000mm is ±4mm. This product range has been designed for engine running below 1200rpm. For higher speed, please contact IAC Acoustics. Figures given above are based on an air temperature of 20°C

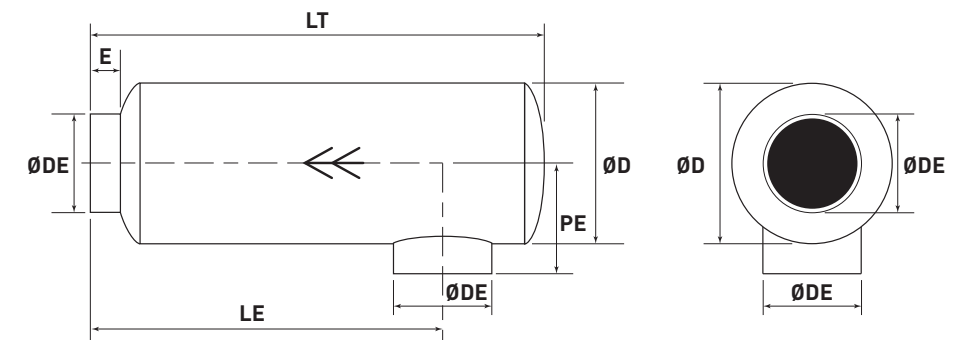
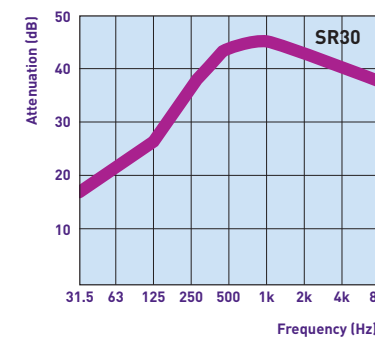

SR40

Nominal Diameter	50	65	80	100	125	150	175	200	225	250	300	350
Qv m ³ /h	240	380	530	860	1270	1860	2600	3330	4230	5240	7430	9000
ΔP (Pa)	3533	3101	2629	2835	2533	2620	2763	2657	2677	2695	2613	2070
ØD (mm)	305	355	405	455	455	608	608	658	708	758	808	908
PE (mm)	222	248	272	298	328	404	414	439	464	489	523	574
LE (mm)	760	970	1080	1260	1550	1795	1945	2305	2430	2700	3060	3113
E (mm)	70	70	70	70	100	100	110	110	110	110	110	120
LT (mm)	890	1100	1255	1445	1760	2070	2200	2610	2810	3135	3520	3515
Weight (kg)	23	36	47	60	76	145	175	225	260	340	415	583
ØDE (mm)	60	76	89	114	140	168	194	220	246	274	324	356

Dimensions are quoted without flange. Please add 4mm for each welded flange. Tolerances for silencer lengths up to 4000mm is ±4mm. This product range has been designed for engine running below 1200rpm. For higher speed, please contact IAC Acoustics. Figures given above are based on an air temperature of 20°C

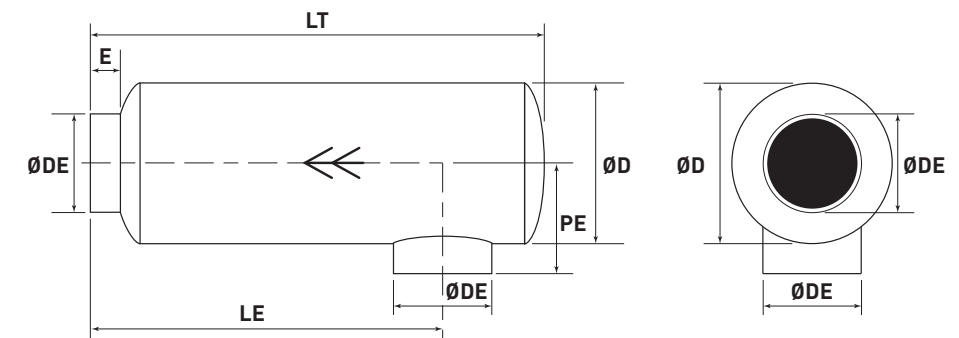
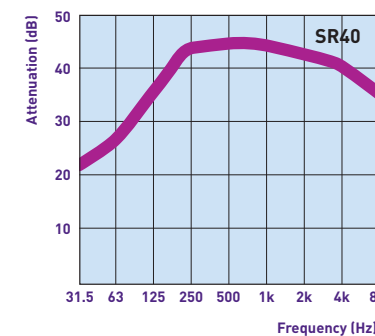

SR40S - Single Piece or in Two Angled Pieces

Nominal Diameter	50	65	80	100	125	150	175	200	225	250	300	350	400	450	500
Qv m³/h	140	220	310	500	760	1110	1500	1940	2440	3050	4390	5200	6800	8550	10600
ΔP (Pa)	1683	1456	1260	1342	1270	1307	1288	1263	1247	1278	1277	967	970	957	965
ØA (mm)	470	520	570	620	620	770	770	820	870	920	970	1070	1120	1170	1270
ØB (mm)	154	154	204	204	254	304	304	354	404	454	504	555	655	758	858
DN1 (mm)	50	65	80	100	125	150	175	220	225	250	300	350	400	450	500
DN2 (mm)	*20	*25	*32	*40	50	65	80	100	100	125	125	150	175	200	225
F (mm)	360	400	465	460	540	585	605	705	705	730	805	770	820	920	900
ØP (mm)	300	350	400	450	450	600	600	650	700	750	800	900	950	1000	1100
H* (mm)	140	150	170	190	210	240	270	320	320	370	370	430	480	530	600
ØG (mm)	16	16	16	18	18	18	18	20	20	20	20	24	24	24	24
R (mm)	110	140	145	160	145	210	195	210	220	230	230	260	260	260	285
S (mm)	235	335	360	385	385	460	460	485	510	535	560	610	635	660	710
T (mm)	60	60	60	80	80	80	80	100	100	100	100	150	150	150	150
Weight (kg)	55	70	85	110	120	190	230	290	340	410	480	610	770	960	1150
LA (mm)	310	390	485	595	715	910	995	1145	1315	1485	1645	1945	2150	2425	2635
LT (mm)	1060	1230	1395	1585	1895	2190	2325	2675	2930	3230	3530	3700	4090	4570	4850
Weight (kg)	61	78	94	122	136	212	260	320	380	460	550	670	850	1050	1260
LB	535	655	770	920	1070	1315	1480	1650	1875	2105	2340	2645	2995	3320	3615
LV	940	1050	1140	1260	1490	1625	1720	1945	2075	2250	2445	2360	2615	2890	3030

Dimensions are quoted without flange. Please add 4mm for each welded flange. Tolerances for silencer lengths up to 4000mm is ±4mm.

This product range has been designed for engine running below 1200rpm. For higher speed, please contact IAC Acoustics

Figures given are based on an air temperature of 20°C

SR40S (single piece)
SR40S (two pieces)

* modifiable on demand

Water and Oil Separation

The SR40S range of water separator silencers is designed for the flow of liquid or water injection vacuum pumps and have an acoustic performance identical to the SR40 range. Depending on the installation, the SR40S can be provided in two versions, as a single piece or in two angled sections.

Oil separation silencers are designed to reduce the noise caused by compressed air containing oil particles escaping from machinery such as drop hammers, cylinder outflows and pneumatic presses. Once connected to an oil storage tray, this range of silencers are self-cleaning and require only periodic maintenance. Also available in galvanised and stainless steel, internal parts can be dismantled for routine cleaning and maintenance.

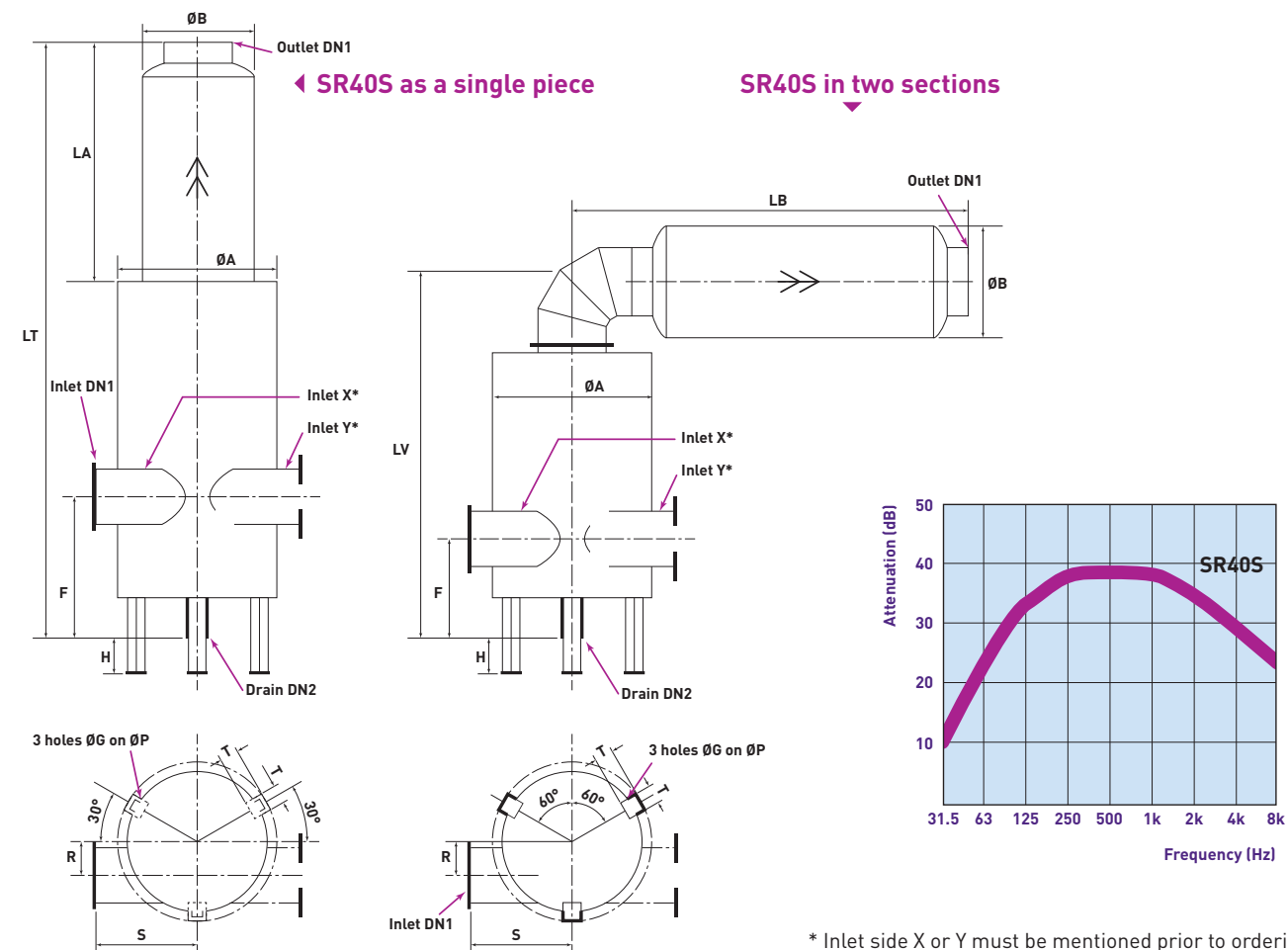

* Inlet side X or Y must be mentioned prior to ordering

Discharge Silencers

If the service pressure is above 0.5 bar, then silencers are subject the Pressure Equipment Directive. In this case, the risk category to which the machinery is subject needs to be determined and the corresponding regulatory requirements need to be applied at the design, control, construction and labelling stages.

EC labelling will be applied when PED asks for a mandatory requirement.

Pressure Equipment Directive (97/23/EC)

The following diagram describes how to correctly choose the correct equipment at given levels of pressure and volume.

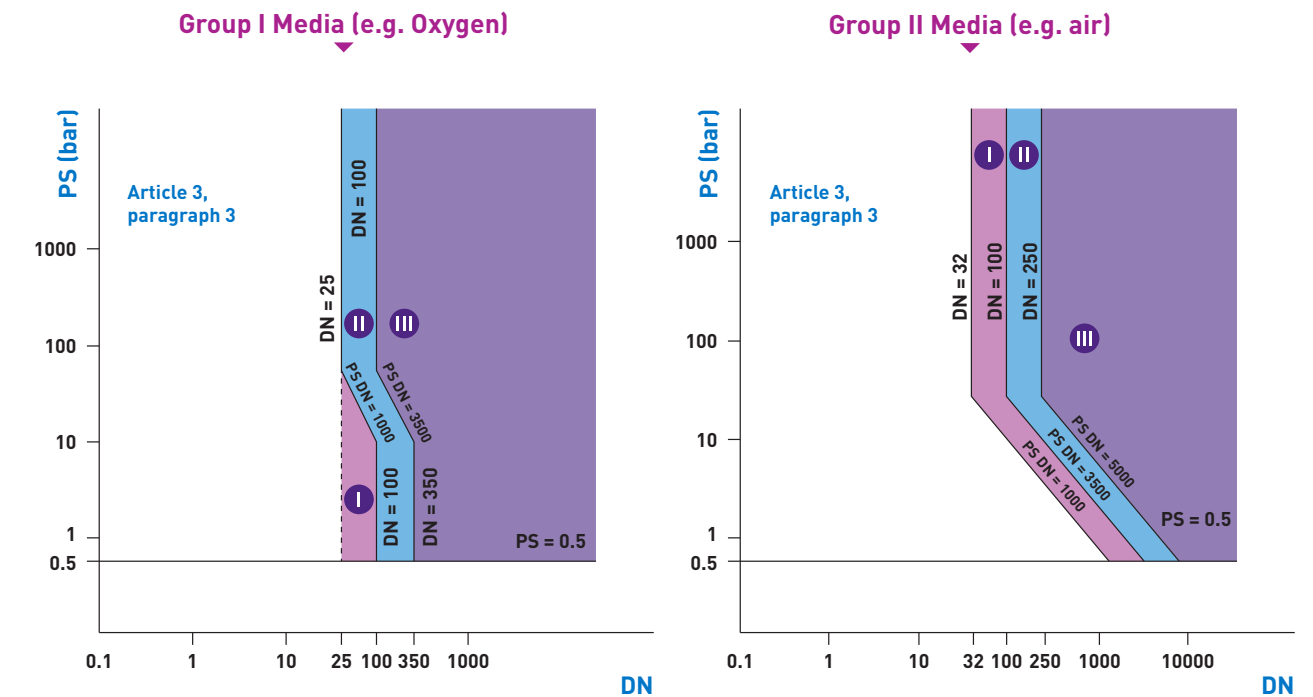

**Head Office - Winchester, UK****T:** +44 (0) 1962 873 000**E:** info@iac-uk.com**Australia****T:** +61 (0) 2 8781 0400**F:** +61 (0) 2 9725 2939**E:** info@iac-australia.com.au**China (Dongguan Office)****T:** +86 (0) 769 89899966 802**F:** +86 (0) 769 89899966 810**E:** china.sales@iac-china.com**China (SH Office)****T:** +86 (0) 21 68825328**E:** test@iac-china.com**Denmark****T:** +45 36 77 88 00**E:** mail@iac-nordic.dk**Germany****T:** +49 (0) 2163 9991 0**F:** +49 (0) 2163 9991 23**E:** deutschland@iac-gmbh.de**Ireland****T:** +33 (0) 3 20 05 88 88**F:** +33 (0) 3 20 05 88 99**E:** ireland.info@iac-noisecontrol.com**Israel****T:** +972 894 284 83**F:** +972 894 284 86**E:** hna.info@iac-noisecontrol.com**Italy****T:** +39 0445 575 669**F:** +39 0445 575 002**E:** italy.info@iac-noisecontrol.com**Kuwait****T:** +965 2294 2000**E:** kuwait.info@iac-noisecontrol.com**United Arab Emirates****T:** +971 (0) 4451 7877**E:** uae.info@iac-noisecontrol.com